

PhlatLight® White LED Illumination Products

SST-90 Series

Features

- Extremely high optical output: Over 2,250 lumens from a single chip (white)
- Extremely high efficiency: Over 100 lumens per watt at 3.15A
- High thermal conductivity package - junction to case thermal resistance of only 0.64 °C/W
- Large, monolithic chip with uniform emitting area of 9 mm²
- Lumen maintenance of greater than 70% after 60,000 hours
- Environmentally friendly: RoHS compliant
- Variable drive currents: less than 1 A through 9 A to full reliability specifications.
- High reliability
- Electrically isolated thermal path

Applications

- Replacement Lamps
- Architectural Lighting
- Retail Lighting
- Residential Lighting
- Consumer Portable
- Spot Lighting
- High Bay Lighting
- Wide Area Lighting
- Street Lighting

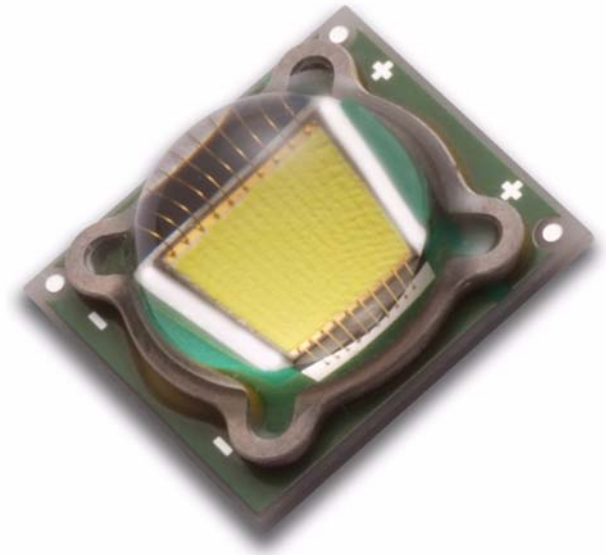

PhlatLight® LEDs enable a new class of illumination applications.

Table of Contents

Technology Overview.....	2
Test Specifications.....	2
PhlatLight Bin Codes.....	3
Product Shipping and Labeling Information.....	7
Optical and Electrical Characteristics	8
Spectral Characteristics.....	10
Radiation Patterns	11
Thermal Resistance	12
Mechanical Dimensions - Emitter	13
Mechanical Dimensions - Star	14
Soldering Profile	15
Ordering Information	16

Technology Overview

PhlatLight LEDs benefit from a suite of innovations in the fields of chip technology, packaging, and thermal management. These breakthroughs allow illumination designers to achieve efficient light engine designs and deliver high brightness solutions.

PhlatLight Technology

The name PhlatLight is derived from Photonic Lattice. Photonic lattice technology creates true surface emission from the source, which enables large area LED chips with uniform brightness over the entire LED chip surface. The optical power and brightness produced by these large monolithic chips enable solutions which replace arc and halogen lamps where arrays of traditional high power LEDs cannot.

Packaging Technology

Thermal management is critical in high power LED applications. With a thermal resistance from junction to case of $0.64^{\circ}\text{C}/\text{W}$, PhlatLight SST-90 devices have the lowest thermal resistance of any LED on the market. This allows the LED to be driven at higher current densities while maintaining a low junction temperature, thereby resulting in brighter and longer lifetimes. The package is easy to use, and ready to be mounted in the lighting system.

Reliability

Designed from the ground up, PhlatLight LEDs are one of the most reliable light sources in the world today. PhlatLight LEDs have passed a rigorous suite of environmental and mechanical stress tests, including mechanical shock, vibration, temperature cycling and humidity, and have been fully qualified for use in extreme high power and high current applications. With very low failure rates and median lifetimes that are well above 60,000 hours, PhlatLight LEDs are ready for the most demanding applications.

Environmental Benefits

PhlatLight LEDs help reduce power consumption and the amount of hazardous waste entering the environment. All PhlatLight products manufactured by Luminus are RoHS compliant and free of hazardous materials, including lead and mercury.

Understanding PhlatLight Test Specifications

Every PhlatLight LED device is fully tested to ensure that it meets the high quality standards of Luminus' products.

Multiple Operating Points (3.2 A, 9.0 A)

The tables on the following pages provide typical optical and electrical characteristics. Since the LEDs can be operated over a wide range of drive conditions (currents from less than 1.0 A to 9.0 A, and duty cycle from <1% to 100%) multiple drive conditions are listed.

PhlatLight SST-90 devices are production tested at 3.2 A. The values shown at 9.0 A are for additional reference at other possible drive conditions.

PhlatLight White Binning Structure

PhlatLight SST-90 White LEDs are tested for luminous flux and chromaticity at a drive current of 3.15A and placed into one of the following luminous flux (FF) and chromaticity (WW) bins:

For ordering information, please refer to page 16 or PDS-001393: PhlatLight Binning and Labeling.

Flux Bins ($T_J = 25\text{ }^\circ\text{C}$)

Color	Flux Bin (FF)	Minimum Flux (lm) @ 3.15 A	Maximum Flux (lm) @ 3.15 A
W65S 6500K, Standard CRI (typ. 70)	WL	700	850
	WM	850	1,000
	WN	1,000	1,200
W57S 5700K, Standard CRI (typ. 70)	WL	700	850
	WM	850	1,000
	WN	1,000	1,200
W45S 4500K, Standard CRI, (typ. 70)	WL	700	850
	WM	850	1,000
	WN	1,000	1,200
W40M 4000K, Moderate CRI, (typ. 83)	WJ	500	600
	WK	600	700
	WL	700	850
W30M 3000K, Moderate CRI, (typ. 83)	WJ	500	600
	WK	600	700
	WL	700	850

Chromaticity Bins

Luminus' Standard Chromaticity Bins: 1931 CIE Curve

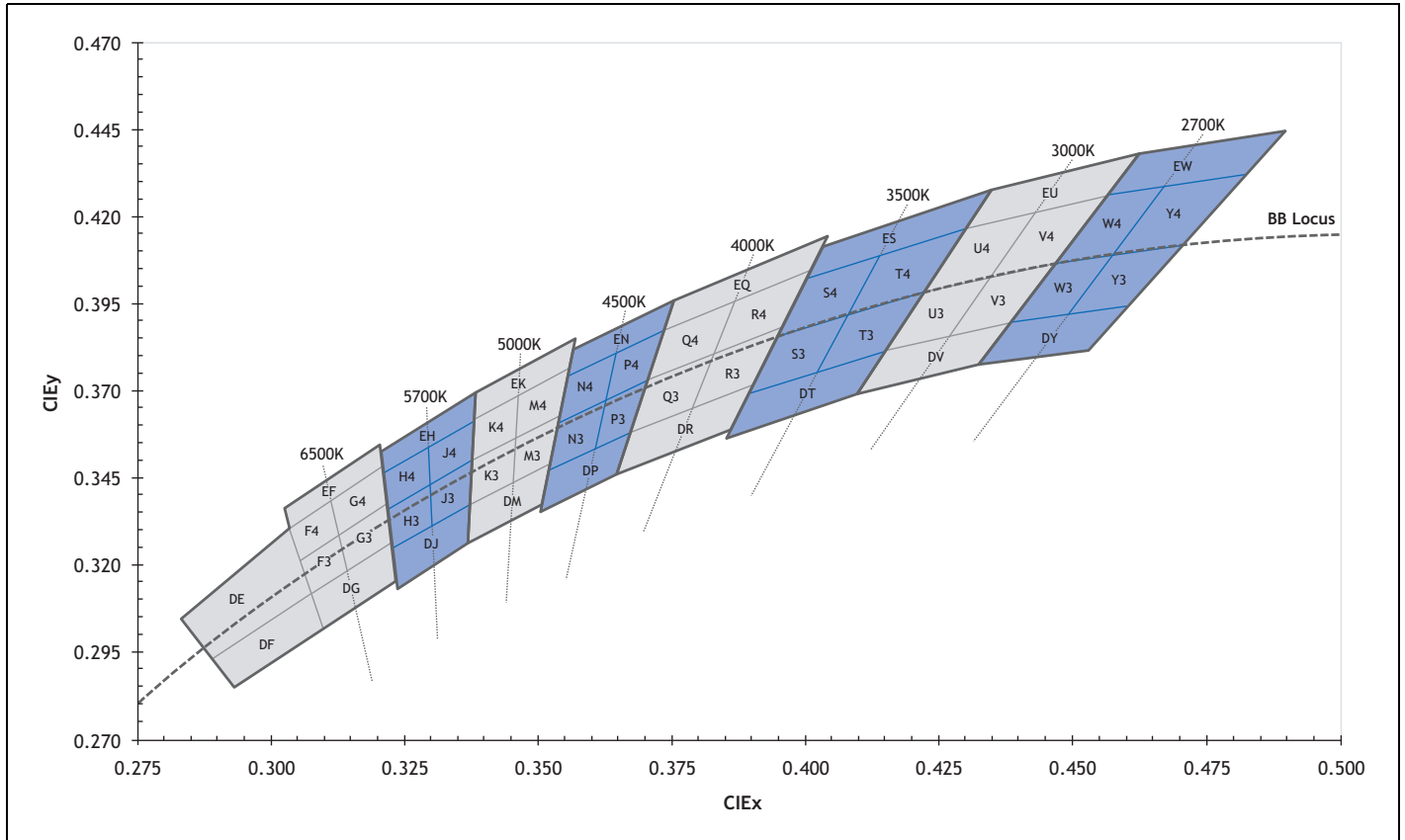

The following tables describe the four chromaticity points that bound each chromaticity bin. Chromaticity bins are grouped together based on the color temperature.

6500K Chromaticity Bins		
Bin Code (WW)	CIE _x	CIE _y
DG	0.307	0.311
	0.322	0.326
	0.323	0.316
	0.309	0.302
F3*	0.305	0.321
	0.313	0.329
	0.315	0.319
	0.307	0.311
F4*	0.303	0.330
	0.312	0.339
	0.313	0.329
	0.305	0.321
G3*	0.313	0.329
	0.321	0.337
	0.322	0.326
	0.315	0.319
G4*	0.312	0.339
	0.321	0.348
	0.321	0.337
	0.313	0.329
EF	0.302	0.335
	0.320	0.354
	0.321	0.348
	0.303	0.330
DE	0.283	0.304
	0.303	0.330
	0.307	0.311
	0.289	0.293
DF	0.289	0.293
	0.307	0.311
	0.309	0.302
	0.293	0.285

5700K Chromaticity Bins		
Bin Code (WW)	CIE _x	CIE _y
DJ	0.322	0.324
	0.337	0.337
	0.336	0.326
	0.323	0.314
	0.321	0.335
H3*	0.329	0.342
	0.329	0.331
	0.322	0.324
	0.321	0.346
H4*	0.329	0.354
	0.329	0.342
	0.321	0.335
	0.329	0.342
J3*	0.329	0.342
	0.337	0.349
	0.337	0.337
	0.330	0.331
J4*	0.329	0.354
	0.338	0.362
	0.337	0.349
	0.329	0.342
EH	0.320	0.352
	0.338	0.368
	0.338	0.362
	0.321	0.346

5000K Chromaticity Bins		
Bin Code (WW)	CIE _x	CIE _y
EK	0.338	0.368
	0.356	0.384
	0.355	0.376
	0.338	0.362
K3*	0.337	0.349
	0.345	0.355
	0.345	0.343
	0.337	0.337
K4*	0.338	0.362
	0.347	0.369
	0.345	0.355
	0.337	0.349
M3*	0.345	0.355
	0.353	0.362
	0.352	0.349
	0.344	0.343
M4*	0.346	0.369
	0.355	0.376
	0.353	0.362
	0.345	0.355
DM	0.337	0.337
	0.352	0.349
	0.350	0.337
	0.336	0.326

* Sub-bins within ANSI defined quadrangles per ANSI C78.377-2008

4500k Chromaticity Bins		
Bin Code (WW)	CIE _x	CIE _y
EN	0.356	0.384
	0.376	0.396
	0.374	0.387
	0.355	0.374
N3*	0.353	0.360
	0.361	0.366
	0.359	0.352
	0.351	0.347
N4*	0.355	0.374
	0.364	0.381
	0.361	0.366
	0.353	0.360
P3*	0.361	0.366
	0.370	0.373
	0.367	0.358
	0.359	0.352
P4*	0.364	0.381
	0.374	0.387
	0.370	0.373
	0.361	0.366
DP	0.351	0.347
	0.367	0.358
	0.364	0.346
	0.350	0.335

4000K Chromaticity Bins		
Bin Code (WW)	CIE _x	CIE _y
EQ	0.376	0.396
	0.404	0.414
	0.401	0.404
	0.374	0.387
Q3*	0.370	0.373
	0.382	0.380
	0.378	0.365
	0.367	0.358
Q4*	0.374	0.387
	0.387	0.396
	0.382	0.380
	0.370	0.373
R3*	0.382	0.380
	0.395	0.388
	0.390	0.372
	0.378	0.365
R4*	0.387	0.396
	0.401	0.404
	0.395	0.388
	0.382	0.380
DR	0.367	0.358
	0.390	0.372
	0.386	0.359
	0.364	0.346

3500K Chromaticity Bins		
Bin Code (WW)	CIE _x	CIE _y
ES	0.403	0.411
	0.435	0.427
	0.430	0.417
	0.400	0.402
S3*	0.394	0.385
	0.407	0.392
	0.402	0.375
	0.389	0.369
S4*	0.400	0.402
	0.415	0.409
	0.407	0.392
	0.394	0.385
T3*	0.407	0.392
	0.422	0.399
	0.415	0.381
	0.402	0.375
T4*	0.415	0.409
	0.430	0.417
	0.422	0.399
	0.407	0.392
DT	0.389	0.369
	0.415	0.381
	0.409	0.369
	0.385	0.357

3000K Chromaticity Bins		
Bin Code (WW)	CIE _x	CIE _y
EU	0.435	0.427
	0.462	0.437
	0.456	0.426
	0.430	0.417
U3*	0.422	0.399
	0.434	0.403
	0.426	0.385
	0.415	0.381
U4*	0.430	0.417
	0.443	0.421
	0.434	0.403
	0.422	0.399
V3*	0.434	0.403
	0.447	0.408
	0.437	0.389
	0.426	0.385
V4*	0.443	0.421
	0.456	0.426
	0.447	0.408
	0.434	0.403
DV	0.415	0.381
	0.437	0.389
	0.431	0.377
	0.409	0.369

2700K Chromaticity Bins		
Bin Code (WW)	CIE _x	CIE _y
EW	0.462	0.437
	0.488	0.444
	0.481	0.432
	0.456	0.426
W3*	0.447	0.408
	0.458	0.410
	0.448	0.392
	0.437	0.389
W4*	0.456	0.426
	0.469	0.429
	0.458	0.410
	0.447	0.408
Y3*	0.458	0.410
	0.470	0.413
	0.459	0.394
	0.448	0.392
Y4*	0.469	0.429
	0.481	0.432
	0.470	0.413
	0.458	0.410
DY	0.437	0.389
	0.459	0.394
	0.452	0.382
	0.431	0.377

* Sub-bins within ANSI defined quadrangles per ANSI C78.377-2008

PhlatLight Product Shipping and Labeling Information

All PhlatLight products are packaged and labeled with their respective bin as outlined in the tables on pages 3 and 4. When shipped, each package will only contain one bin. The part number designation is as follows:

SST — 90 — WNNX — F11 — FF — WW

Product Family	Chip Area	Color	Package Configuration	Flux Bin	Chromaticity Bin
SST:Surface mount	90: 9.0 mm ²	WNNX: CCT and CRI See Note 1 Below	F11: 10 x 11mm emitter	See page 3 for bins	See pages 4-5 for bins

Note 1. WNNX nomenclature corresponds to the following:

W = White

NN = color temperature, where:

65 corresponds to 6500K

40 corresponds to 4000K

30 corresponds to 3000K, etc.

X = color rendering index, where:

S (standard) corresponds to a typical CRI of 70

M (moderate) corresponds to a typical CRI of 83

H (high) corresponds to a typical CRI of 92.

Note 2. Some flux and chromaticity bins may have limited availability. Application specific bin kits, consisting of multiple bins, may be available. For ordering information, please refer to page 16 and reference PDS-001393: PhlatLight Binning and Labeling document.

Example: The part label SST-90-W65S-F11-WN-G4 refers to a 6500K standard CRI white, SST-90 emitter, F11 package configuration, with a flux range of 1,000 to 1,200 lumens and a chromaticity value within the box defined by the four points (0.313, 0.338), (0.321, 0.348), (0.322, 0.336), (0.312, 0.328).

Example: The part label SST-90-W30M-F11-WL-U3 refers to a 3000K moderate CRI white, SST-90 emitter, F11 package configuration, with a flux range of 700 to 850 lumens and a chromaticity value within the box defined by the four points (0.422, 0.399), (0.434, 0.403), (0.426, 0.386), (0.415, 0.381).

Optical and Electrical Characteristics ($T_J = 25\text{ }^\circ\text{C}$)

White				
Drive Condition ¹		3.15 A	9.0 A	
Parameter	Symbol	Typical Values at Test Current	Values at Indicated Currents ²	Unit
Current Density	j	0.35	1.0	A/mm ²
Forward Voltage	V _{F, min}	2.50		
	V _{F, typ}	3.25	3.87	V
	V _{F, max}	3.90		

Common Characteristics

	Symbol	Values	Unit
Viewing Angle	2 $\theta_{1/2}$	100	degrees
Emitting Area		9.0	mm ²
Emitting Area Dimensions		3 x 3	mmxmm
Forward Voltage Temperature Coefficient ³		-2.45	mV/°C

Absolute Maximum Ratings

	Symbol	Values	Unit
Maximum Current ⁴		9	A
Maximum Reverse Current		Not Allowed	A
Maximum Junction Temperature ⁵	T _{j-max}	150	°C
Storage Temperature Range		-40/+100	°C

Note 1: Listed drive conditions are typical for common applications. PhlatLight SST-90-W devices can be driven at currents ranging from <1A to 9A and at duty cycles ranging from <1% to 100%. Drive current and duty cycle should be adjusted as necessary to maintain the junction temperature desired to meet application lifetime requirements.

Note 2: Unless otherwise noted, values listed are typical.

Note 3: Forward voltage temperature coefficient at 3.15 A. Contact Luminus for value at other drive conditions.

Note 4: Luminus PhlatLight SST-90-W LEDs are designed for operation to an absolute maximum forward drive current of 9 A. Product lifetime data is specified at recommended forward drive currents. Sustained operation at absolute maximum currents will result in a reduction of device lifetime compared to recommended forward drive currents. Actual device lifetimes will also depend on junction temperature. Refer to the APN-001522: Reliability Application Note for SST-90-W for further information. In pulsed operation, rise time from 10-90% of forward current should be larger than 0.5 microseconds.

Note 5: Lifetime dependent on LED junction temperature. Thermal calculations based on input power and thermal management system should be performed to ensure T_j is maintained below T_{jmax} rating or life will be reduced. Refer to APN-001522 for further information.

Note 6: CIE measurement uncertainty for white devices is estimated to be +/- 0.01.

Note 7: Special design considerations must be observed for operation under 1 A. Please contact Luminus for further information.

Note 8: Caution must be taken not to stare at the light emitted from these LEDs. Under special circumstances, the high intensity could damage the eye.

Relative Luminous Flux vs. Forward Current ($T_J = 25\text{ }^\circ\text{C}$)¹

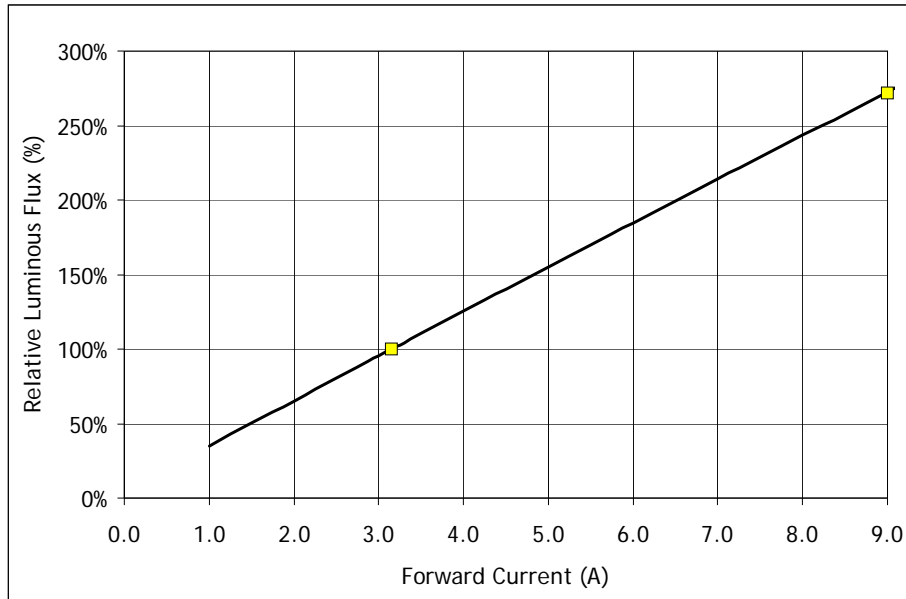

Forward Current vs. Forward Voltage ($T_J = 25\text{ }^\circ\text{C}$)

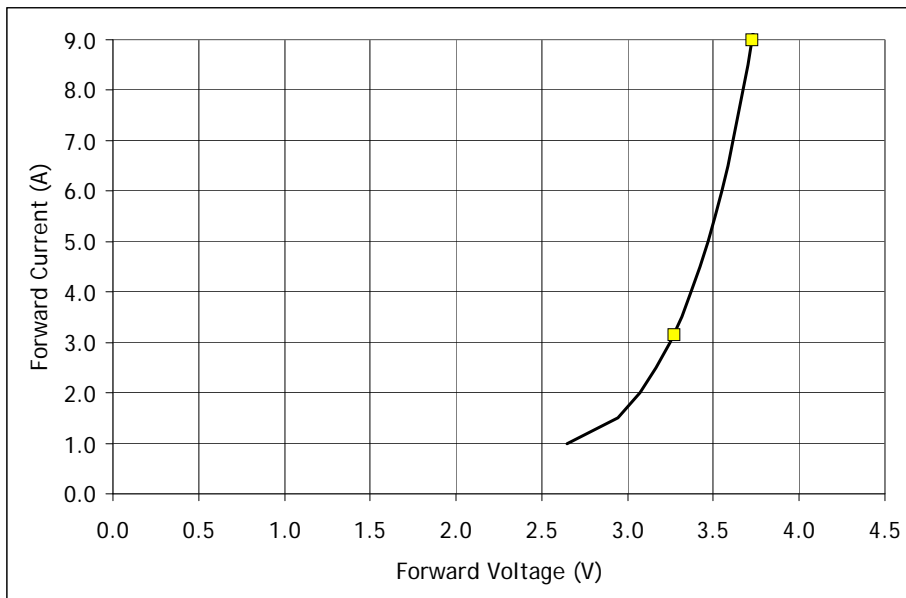

Note1. Yellow squares indicate typical operating conditions

Relative Output Flux vs. Junction Temperature ($I_F = 3.15 \text{ A}$)

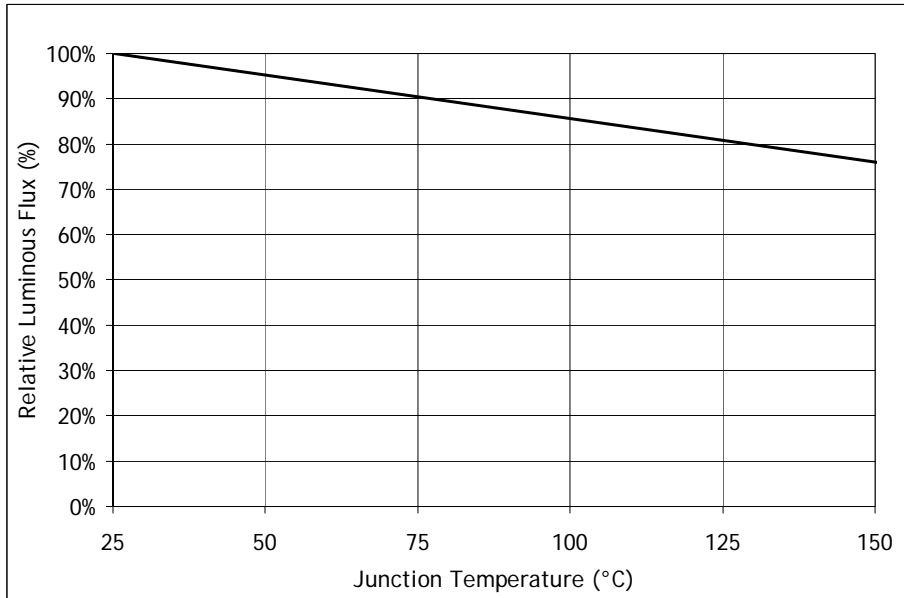

Typical Relative Spectral Power ($T_J = 25^\circ\text{C}$)

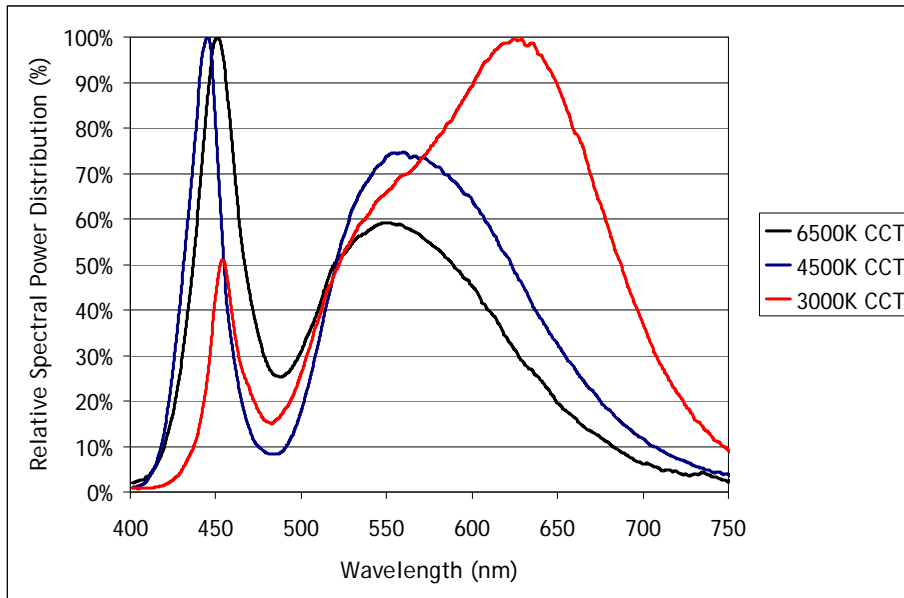

Typical Polar Radiation Pattern

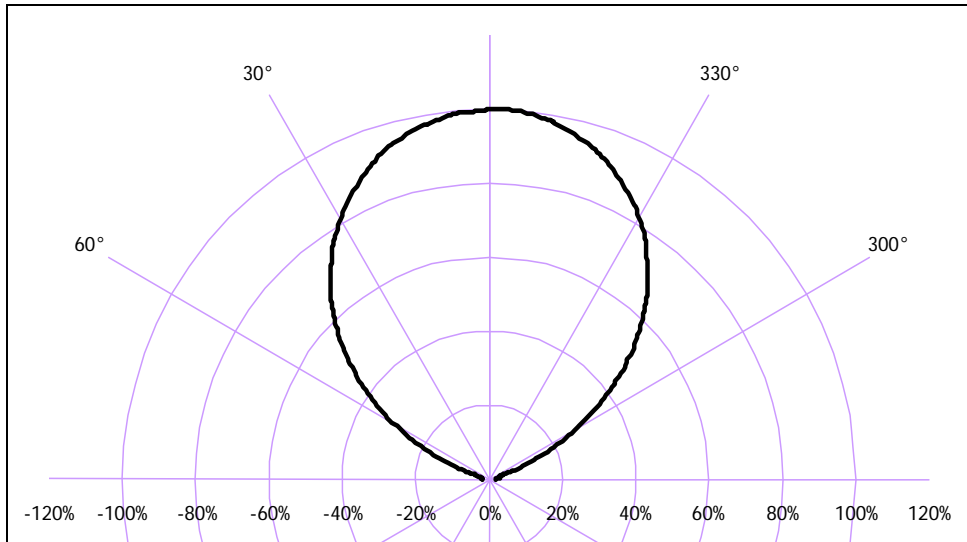

Typical Angular Radiation Pattern

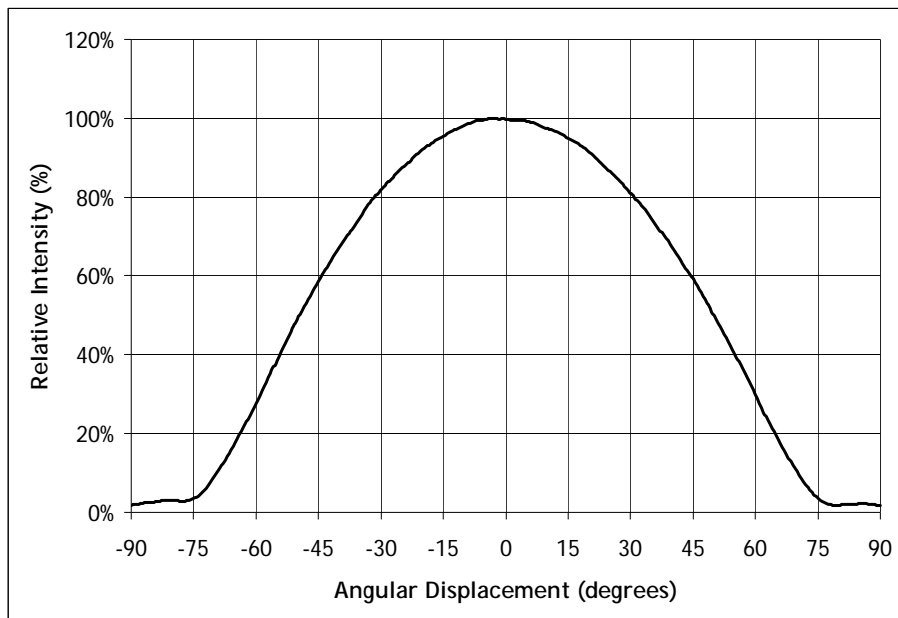

Thermal Resistance

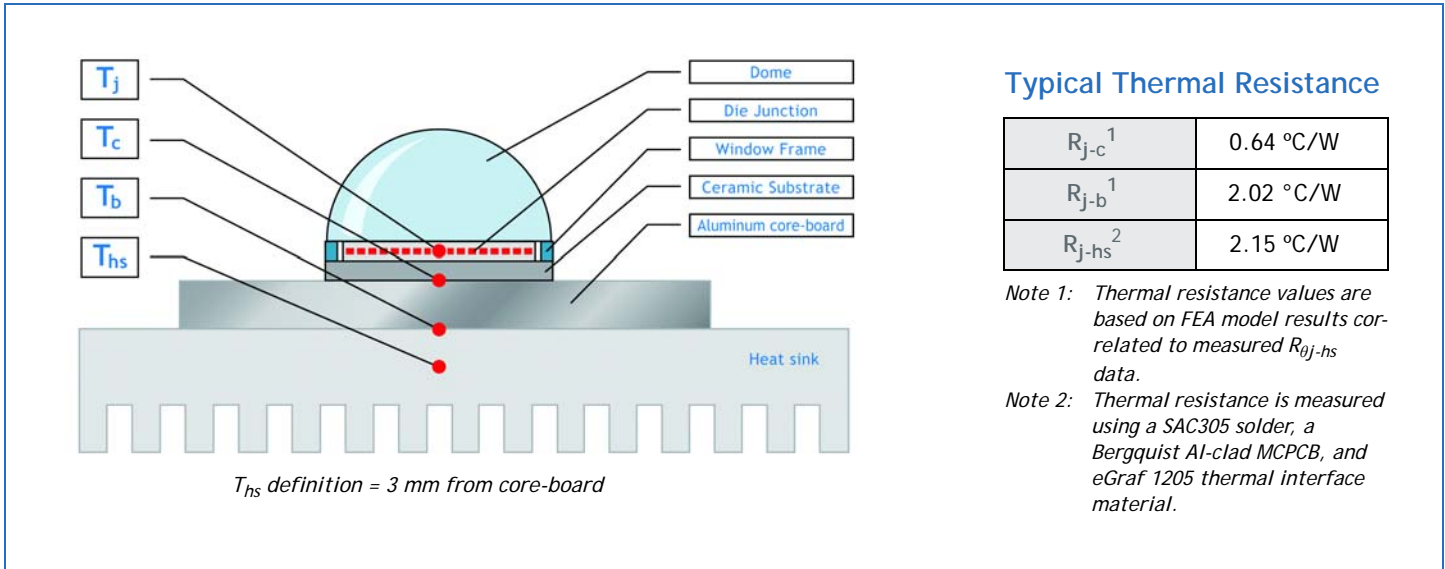

Typical Thermal Resistance

R_{j-c}^1	0.64 °C/W
R_{j-b}^1	2.02 °C/W
R_{j-hs}^2	2.15 °C/W

Note 1: Thermal resistance values are based on FEA model results correlated to measured R_{ij-hs} data.

Note 2: Thermal resistance is measured using a SAC305 solder, a Bergquist Al-clad MCPCB, and eGraf 1205 thermal interface material.

Mechanical Dimensions - SST-90 Emitter

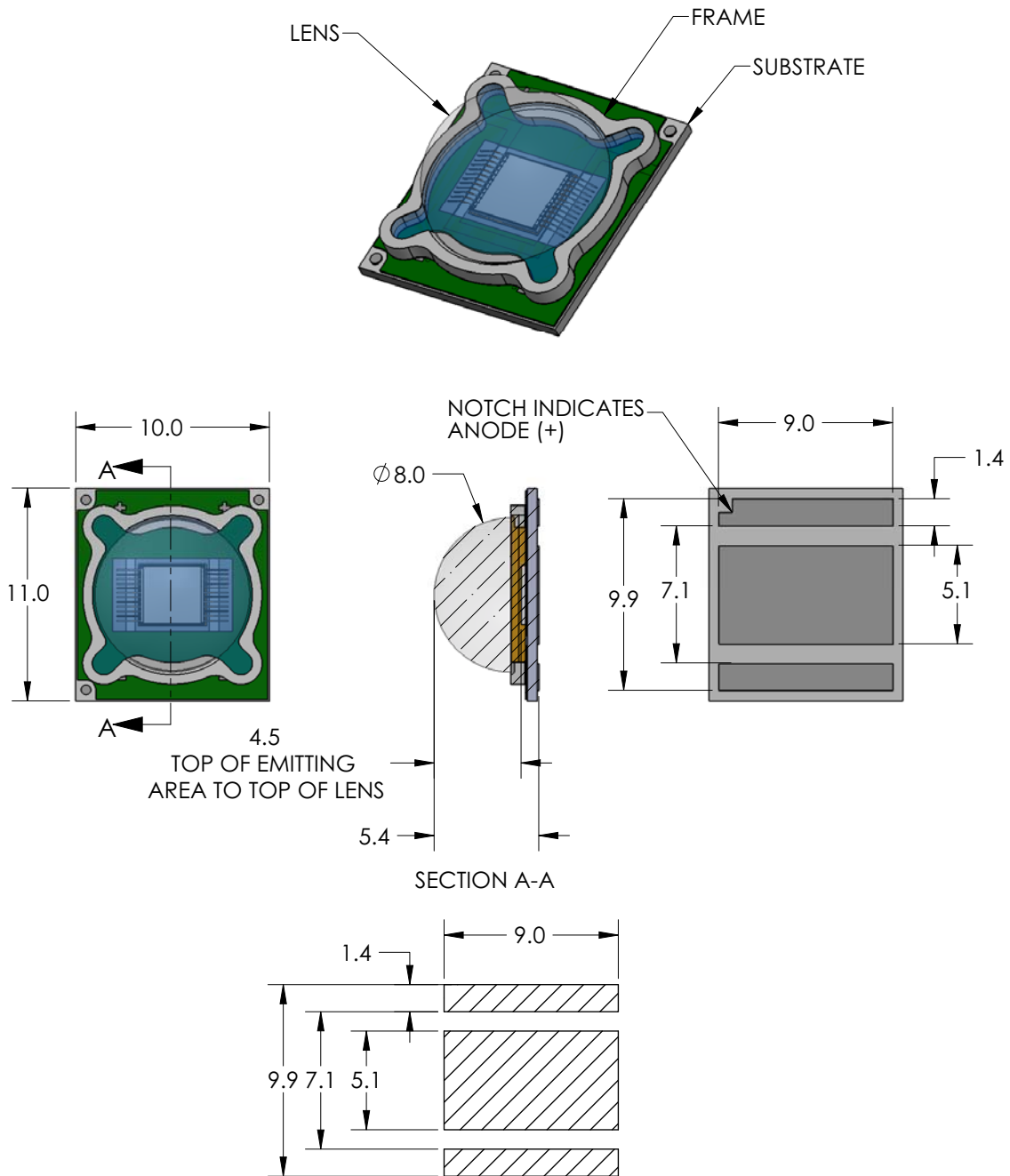

For detailed drawing please refer to DWG-001359 document

Mechanical Dimensions - SST-90 Star

PhlatLight SST-90-W devices are available on a star board for prototyping purposes. Please see page 16 for ordering information.

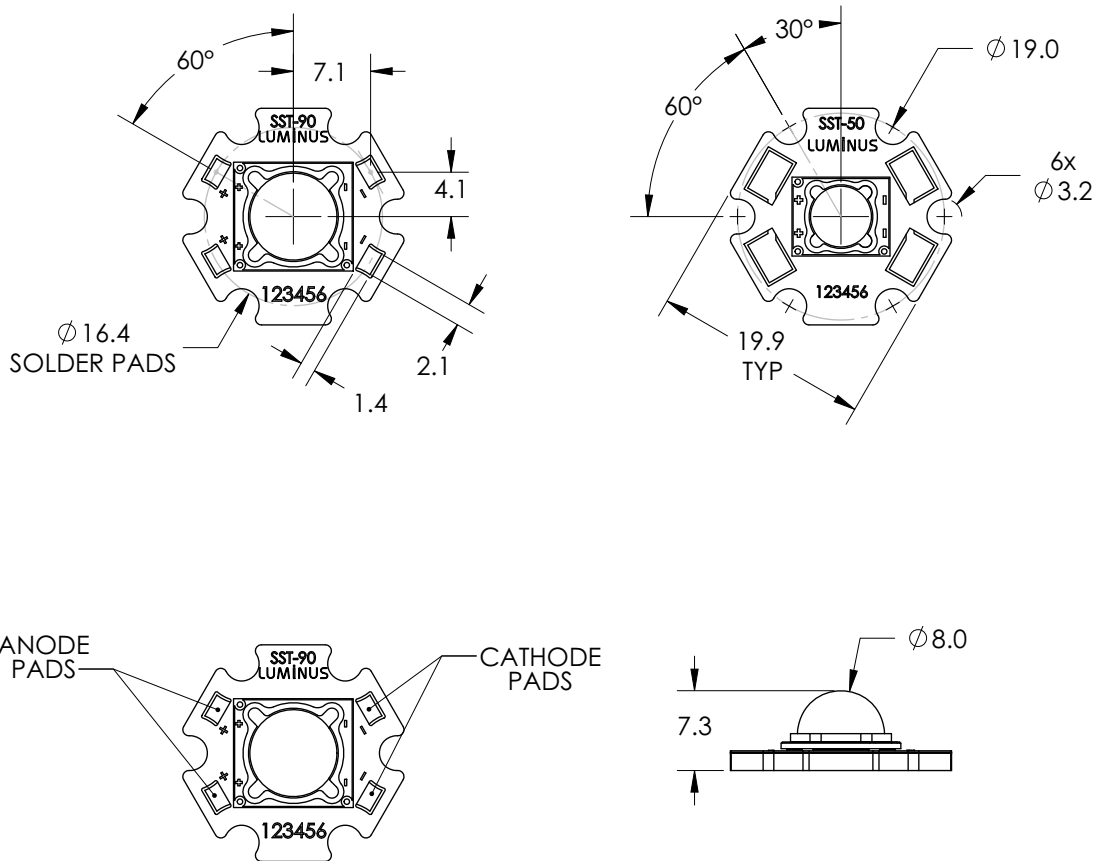

Notes:

1. Recommended mounting screw: M3 or #4
2. All dimensions in millimeters
3. All anode pads on board are interconnected. All cathode pads on board are interconnected

Reflow Soldering Characteristics

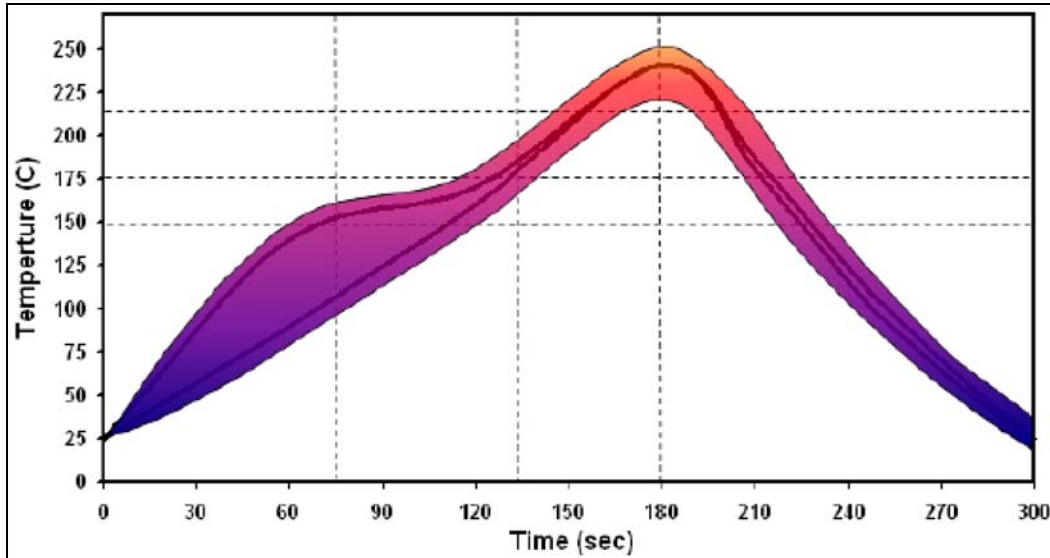

Solder profile guideline

Solder Profile Stage	Lead-free solder	Lead-based solder
Profile Length, Ambient to Peak	2.75 - 3.5 minutes	2.75 - 3.5 minutes
Time Maintained Above: Temperature	217 °C	183 °C
Time Maintained Above: Time	30 - 60 seconds	30-60 seconds
Cooldown Rate	≤ 4° C/sec	≤ 4° C/sec
Cooldown Duration	45 ± 15 sec	45 ± 15 sec

- Note: 1. Temperatures are taken and monitored at the component copper layer
 Note: 2. Optimum profile may differ due to oven type, circuit board or assembly layout
 Note: 3. Recommended lead free, no-clean solder: AIM NC254-SAC305
 Note: 4. Refer to APN-001473: PhlatLight Soldering and Handling application note for additional solder profiles and details.

Ordering Information

Ordering Part Number ^{1,2}	Color	Description
SST-90-WDLS-F11-GL150	6500K White 5700K White	White PhlatLight SST-90 surface mount device consisting of a domed 9mm ² LED mounted on a ceramic substrate.
SST-90-WCLS-F11-GL350	5000K White 4500K White	White PhlatLight SST-90 surface mount device consisting of a domed 9mm ² LED mounted on a ceramic substrate.
SST-90-WWTS-F11-GJ550	4000K White 3500K White	White PhlatLight SST-90 surface mount device consisting of a domed 9mm ² LED mounted on a ceramic substrate.
SST-90-WWRM-F11-GJ750	3000K White 2700K White	White PhlatLight SST-90 surface mount device consisting of a domed 9mm ² LED mounted on a ceramic substrate.
SSR-90-WDLS-R11-GL150	6500K White 5700K White	PhlatLight SSR-90 evaluation module consisting of a SST-90 surface mount device mounted on an aluminum star board.
SSR-90-WCLS-R11-GL350	5000K White 4500K White	PhlatLight SSR-90 evaluation module consisting of a SST-90 surface mount device mounted on an aluminum star board.
SSR-90-WWTS-R11-GJ550	4000K White 3500K White	PhlatLight SSR-90 evaluation module consisting of a SST-90 surface mount device mounted on an aluminum star board.
SSR-90-WWRM-R11-GJ750	3000K White 2700K White	PhlatLight SSR-90 evaluation module consisting of a SST-90 surface mount device mounted on an aluminum star board.

Note 1: GL150 - denotes a bin kit comprising of all flux and chromaticity bins at the 6500K and 5700K color points
 GL350 - denotes a bin kit comprising of all flux and chromaticity bins at the 5000K and 4500K color points
 GJ550 - denotes a bin kit comprising of all flux and chromaticity bins at the 4000K and 3500K color points
 GJ750 - denotes a bin kit comprising of all flux and chromaticity bins at the 3000K and 2700K color points
 See PDS-001393: PhlatLight Binning and Labeling document for more information.

Note 2: For ordering information on all available bin kits, please see PDS-001393: PhlatLight Binning and Labeling document.

www.luminus.com

The products, their specifications and other information appearing in this document are subject to change by Luminus Devices without notice. Luminus Devices assumes no liability for errors that may appear in this document, and no liability otherwise arising from the application or use of the product or information contained herein. None of the information provided herein should be considered to be a representation of the fitness or suitability of the product for any particular application or as any other form of warranty. Luminus Devices' product warranties are limited to only such warranties as accompany a purchase contract or purchase order for such products. Nothing herein is to be construed as constituting an additional warranty. No information contained in this publication may be considered as a waiver by Luminus Devices of any intellectual property rights that Luminus Devices may have in such information. PhlatLight[®] is a registered trademark of Luminus Devices, Inc., all rights reserved.

This product is protected by U.S. Patents 6,831,302; 7,074,631; 7,083,993; 7,084,434; 7,098,589; 7,105,861; 7,138,666; 7,166,870; 7,166,871; 7,170,100; 7,196,354; 7,211,831; 7,262,550; 7,274,043; 7,301,271; 7,341,880; 7,344,903; 7,345,416; 7,348,603; 7,388,233; 7,391,059; Patents Pending in the U.S. and other countries.